

ARTICULÉES



NACELLES DE 14 À 22 M SUR VL

**EUROSKY**

**IMER**  
TP ACCESS



# NACELLES SUR VL **EUROSKY**

↳ 2 marques de porteurs :  
Nissan | Iveco | Autres sur demande

↳ Charge utile 200 kg sur tous les modèles

↳ Nacelle avec tourelle haute pour plus de compacité en longueur



↳ Commandes du panier avec prise électrique 230 V

↳ Tous les flexibles sont dans les mâts

↳ Panier fibre pour isolement électrique jusqu'à 5000 V (en option)

↳ Facilité d'accès  
Poignées et arc-  
ceau rabattable sur le panier

↳ Echelle réversible

↳ Rangements pour cales

↳ Protection pare cycliste



↳ Moteur de rotation hydraulique sur le panier



↳ Commandes des pieds stabilisateurs



↳ Capteurs de charge



↳ Réservoir hydraulique intégré directement dans le châssis

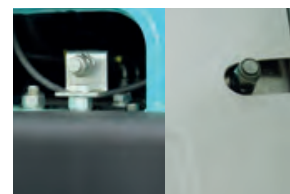

↘ **Commandes d'urgence**  
 Trappe avec système de coupure pour commande panier



↘ **Commandes basses**



↘ **Travail en basse pression, pour plus de précision et de souplesse**

↘ **Commandes 100% hydrauliques pour plus de précision**

## ↘ **Equipements standards**

- + Rotation continue 360° de la tourelle
- + Double pantographe
- + Bras télescopique
- + Bras articulé terminal JIB
- + Panier en aluminium 1400 x 700 x 1100 mm
- + Commandes hydrauliques basse pression
- + Limiteur de charge sur le panier
- + Prise électrique 230 V - 30 mA
- + Allumage/Extinction du moteur depuis le panier
- + Gyrophare
- + Priorité des commandes du panier
- + Attaches pour les ceintures de sécurité sur le panier
- + Kit clapets de sécurité sur les cylindres
- + Pompe manuelle pour descente d'urgence
- + Alarme si la prise de force est activée
- + Filtre en pression
- + Fin de course des stabilisateurs à terre
- + Rotation du panier 90° + 90°
- + Nivellement hydraulique du panier
- + Compteur d'heures
- + 2 casques de protection
- + 2 harnais de sécurité
- + 2 paires de gants
- + 2 lunettes
- + Protections latérales pare-cyclistes
- + Prise air/eau
- + 2 coffres à outils 1100 x 340 x 350 mm en acier inox
- + 4 cales stabilisatrices et supports de cales

↘ **Tous les modèles sont équipés d'un coffre à outils inox**



↘ **Voyants de fonction de la prise de force**



↘ **Prise électrique 230 V avec 30 mA pour alimentation dans le panier**

↘ **Circuit air/eau**  
 Prise air/eau haut/bas de série sur chaque modèle



↘ **Prise de force électrique avec déclenchement automatique**

↘ **Pieds en H ou en A**  
 Certains modèles peuvent être équipés de pieds en :  
**H** : pieds droits dans le gabarit  
**A** : pieds en biais pour plus de déport

# NACELLES SUR VL **EUROSKY**

## **EUROSKY** **14|2|6 HQ JIB**

90° + 90°	A + A	360° continue	200 kg	6 m	13.5 m

### **PIAGGIO** MAXXI

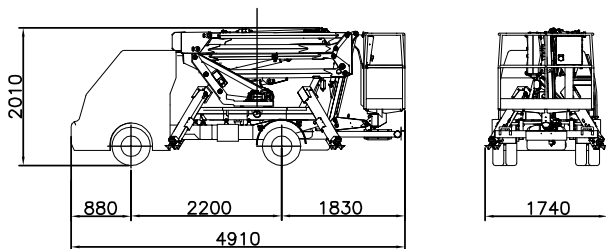



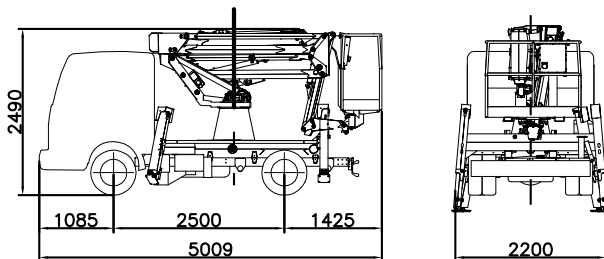

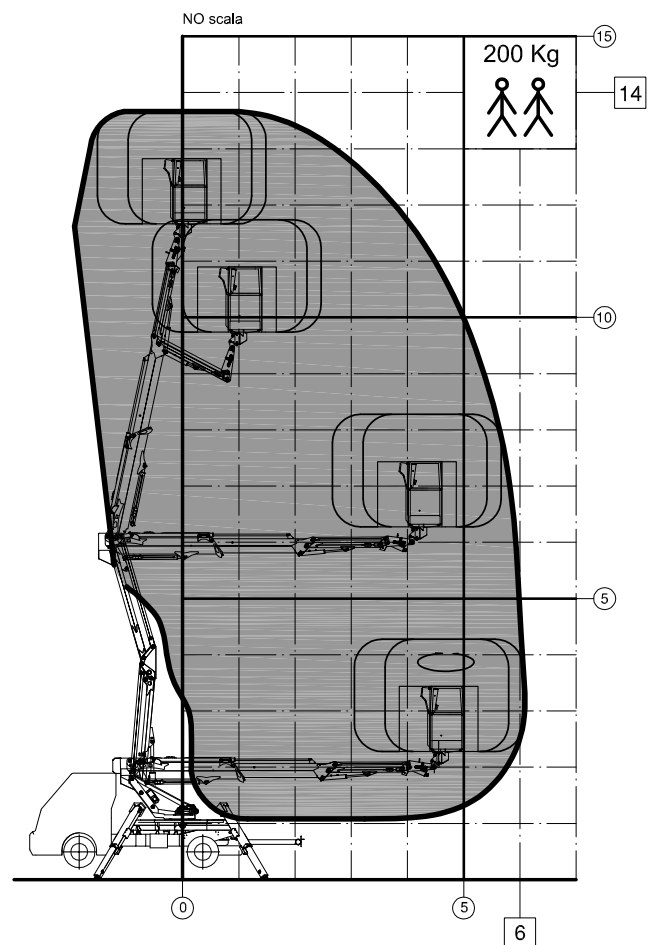
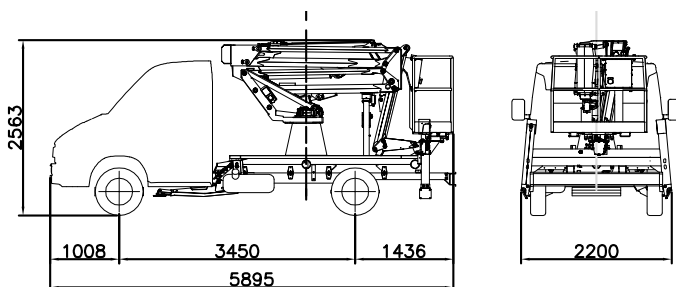

### **NISSAN** CABSTAR



### **IVECO** DAILY



# EUROSKY 16|2|6 (7.5) HQ JIB

-  16 m
-  6 m (7.5 m)
-  200 kg (120 kg)
-  360° continue
-  A + A
-  90° + 90°



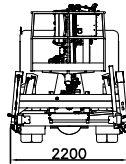
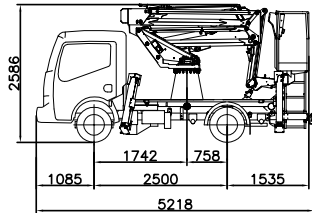

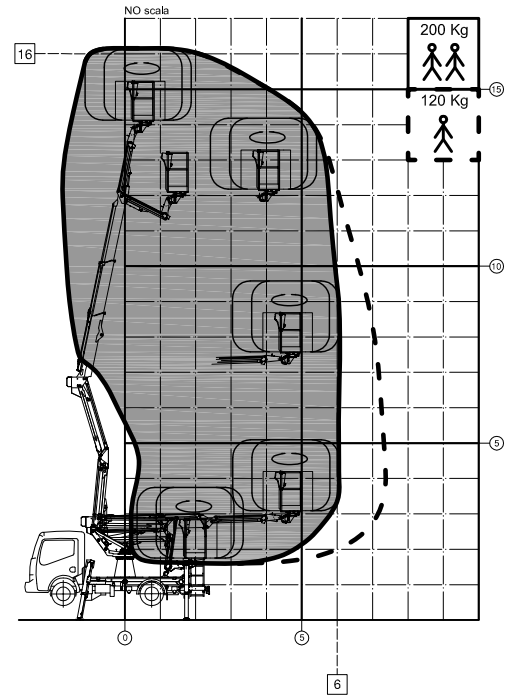
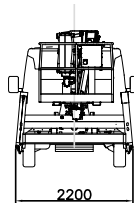
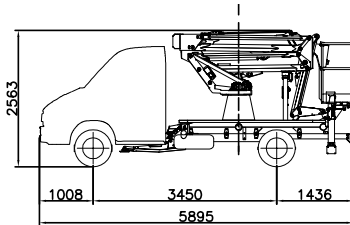

**NISSAN**  
CAB STAR



**IVECO**  
DAILY



# EUROSKY 18|2|7.5 HQ JIB

-  17.5 m
-  7.5 m
-  200 kg
-  360° continue
-  H + H
-  90° + 90°

**NISSAN**  
CAB STAR

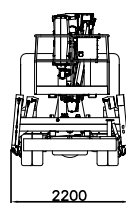
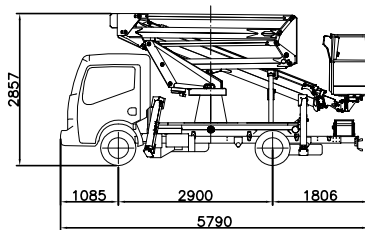

**IVECO**  
DAILY

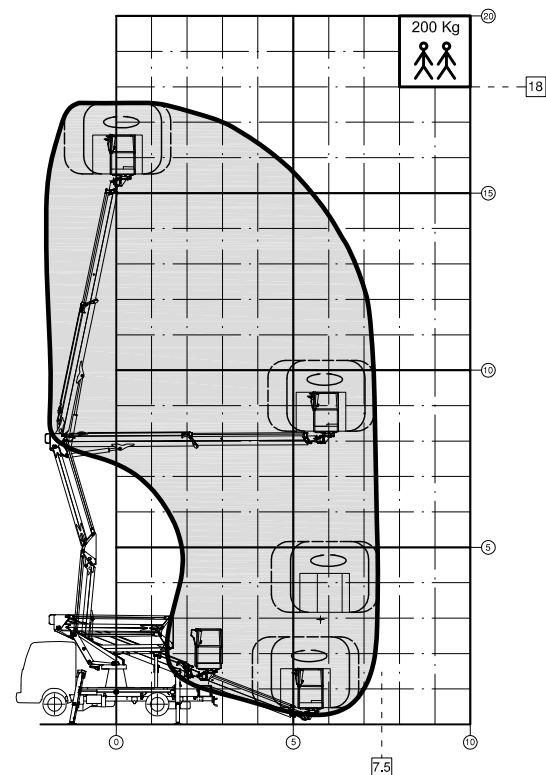
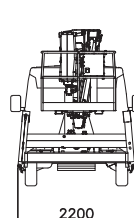
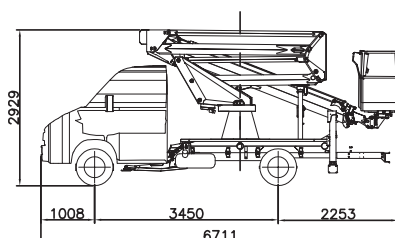

# NACELLES SUR VL **EUROSKY**

## EUROSKY 20|2|10 HQ JIB

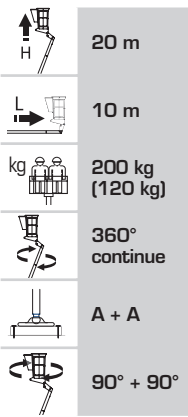

**NISSAN**  
CAB STAR

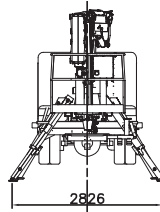
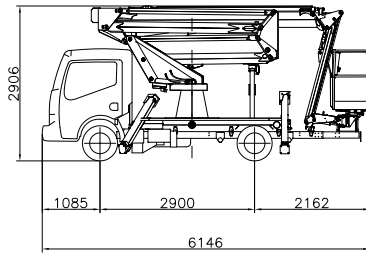

**IVECO**  
DAILY

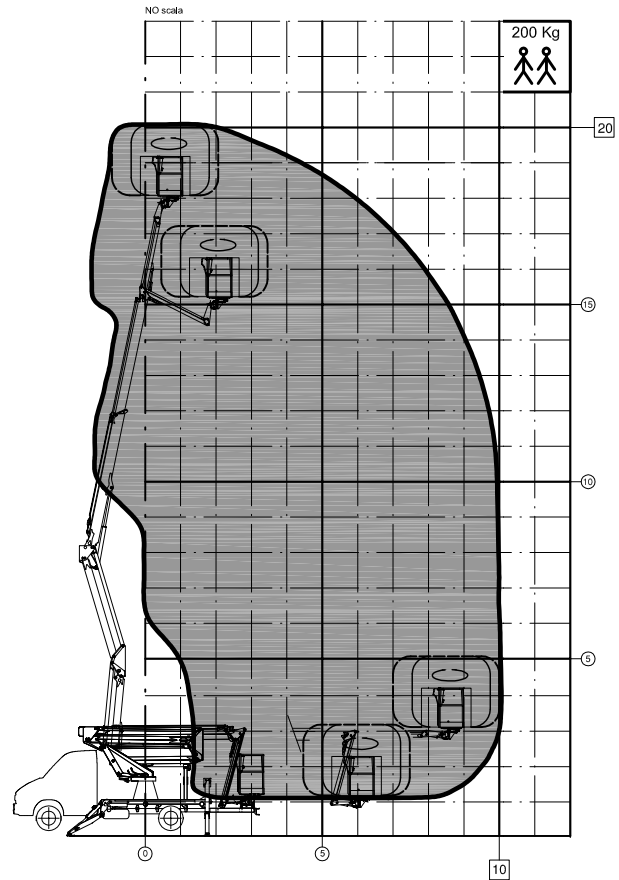
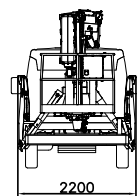
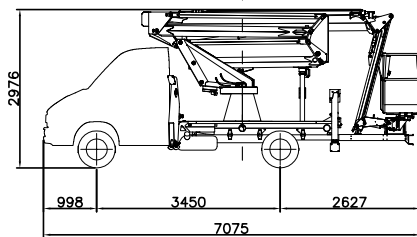

## EUROSKY 21|2|7 (9) HQ



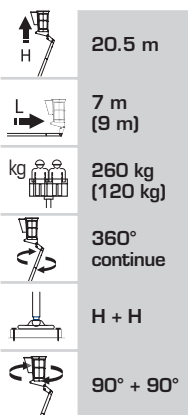

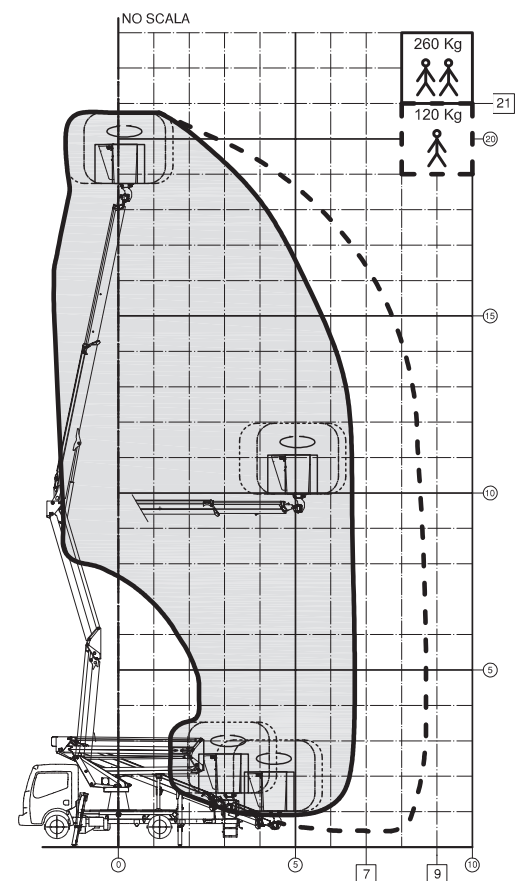
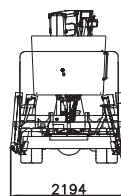
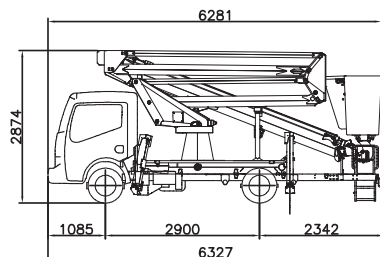

**H+H**  
**260kg**



**NISSAN**  
CAB STAR







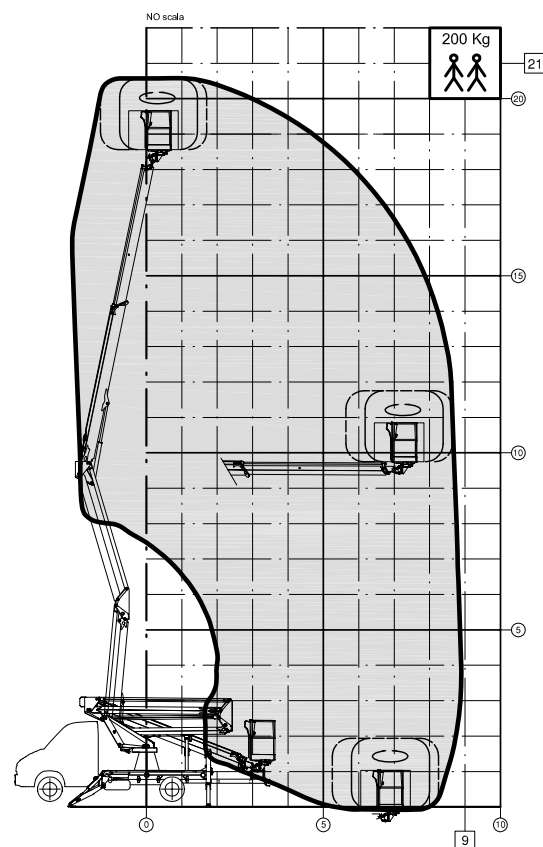
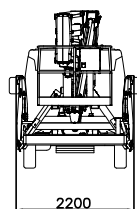
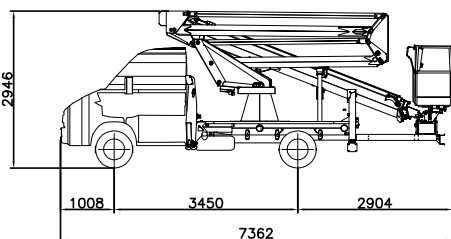
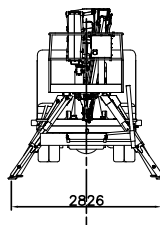
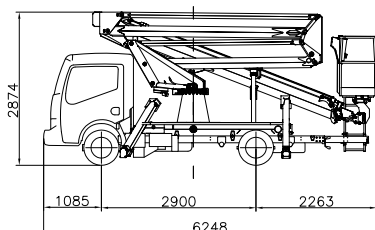

# EUROSKY 21 | 2 | 9 HQ

-  20.5 m
-  9 m
-  200 kg
-  360° continue
-  A + A
-  90° + 90°

## NISSAN CAB STAR



# EUROSKY 22 | 2 | 10 HQ JIB

-  22 m
-  10 m
-  200 kg
-  360° continue
-  A + A
-  90° + 90°

## NISSAN CAB STAR

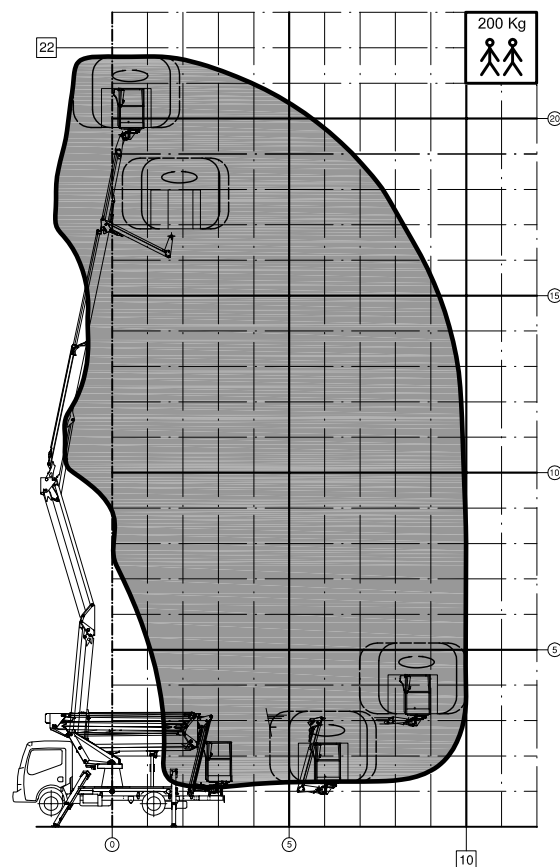
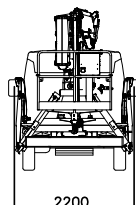
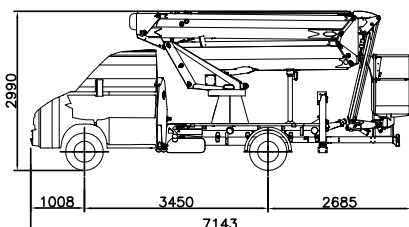
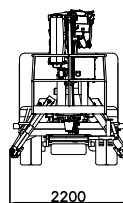
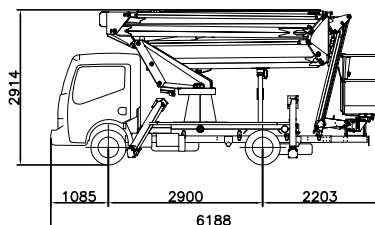

## ↘ Options disponibles

- › Electro-pompe d'urgence 12 / 24 V
- › Electro-pompe auxiliaire 230 V / 50 Hz
- › Phare blanc orientable
- › Ridelles rabattables H. 100 mm
- › Ridelles rabattables H. 200 mm
- › Ridelles fixes H. 100 mm
- › Ridelles fixes H. 200 mm
- › Personnalisation peinture
- › Panier en fibre de verre
- › Panier en fibre de verre isolation + 5000 V
- › Porte-poteaux / Porte-échelle av./ar. démontable
- › Inclinomètre avec alarme sonore
- › Triflash



↘ Panier en fibre de verre en option



↘ Option électrique



↘ Sortie hydraulique  
Pour l'utilisation d'un accessoire

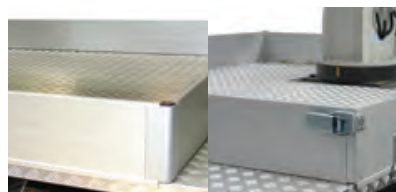

↘ Ridelles fixes ou rabattables



↘ Triflash  
Triflash  
(1 gyrophare + triangle) relevage manuel

ou



Triflash  
(1 feu à éclat + triangle) relevage manuel - homologation autoroute